

KLETON

GEAR LOCKER VENTED W/ DOOR

Assembly Instructions

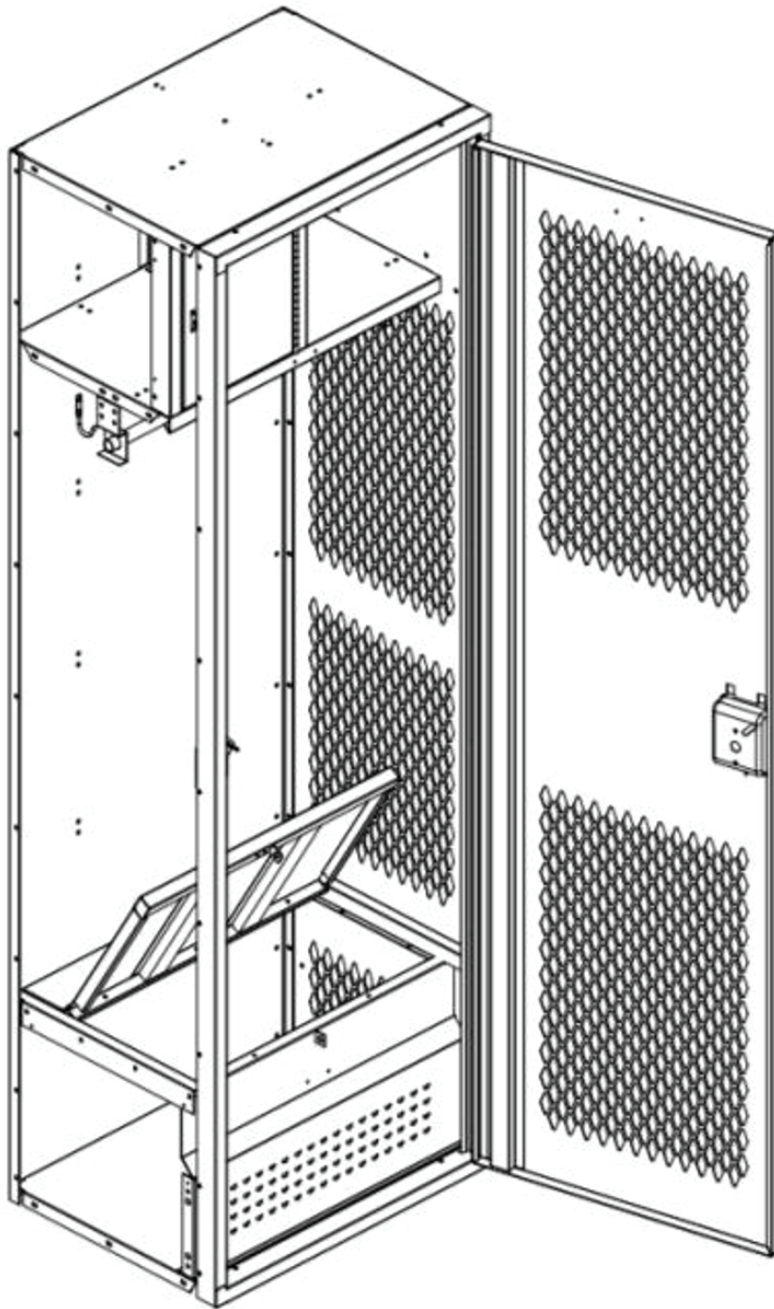

IDENTIFY PARTS

Remove unassembled locker parts from the packaging. Next, locate and identify each part based on the images show below:

TIP: Ensure that the bolts are installed on the outside of locker and nuts are secured on the inside of the locker.

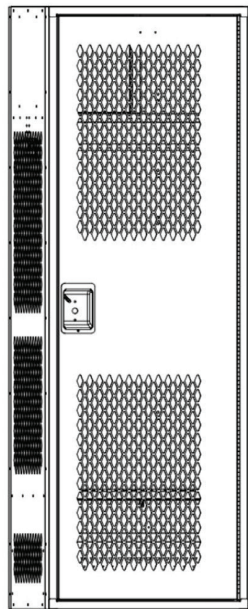

(1) Front Door and Frame

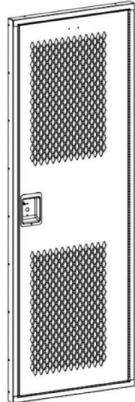

(1) Back Panel

(2) Side Panels

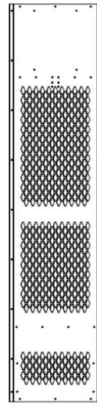

(1) Top Panel

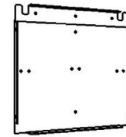

(1) Coat Rod
(2) Brackets

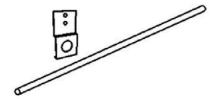

(1) Bottom Shelf

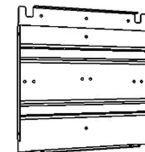

(1) Shelf

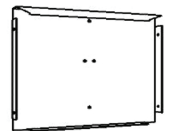

(1) Security Box Side

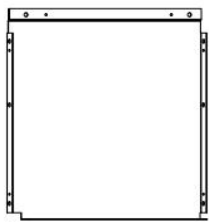

(1) Security Box Door and Frame

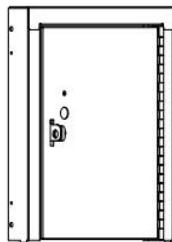

(1) Front footlocker panel

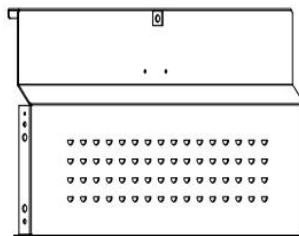

(2) Side Seat Supports

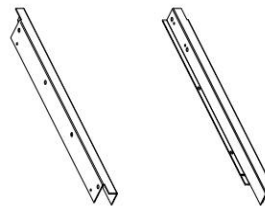

(1) Hinged Seat

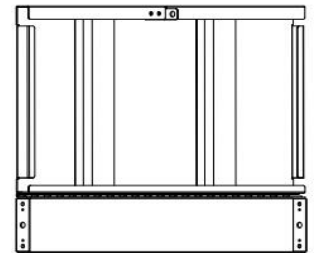

(2) Hooks



START ASSEMBLING

1. Gently bolt the left and right side panels to the inside of the back panel flange.

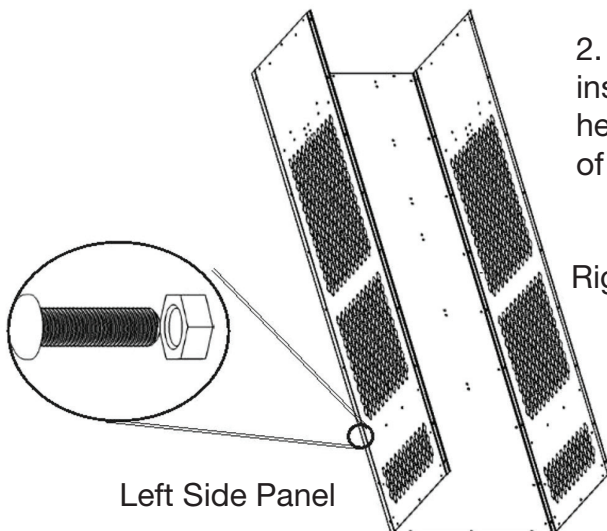

2. Bolt the tamper-proof screw on the inside of the locker. Only the screw heads should be visible from the outside of the locker.

Right Side Panel

Left Side Panel

The left and right side panels must be placed inside the back panel flanges.

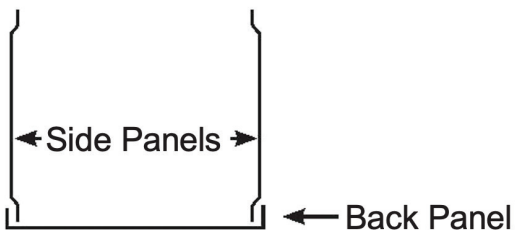

3. Slightly bolt the top/bottom panels, shelf, and coat rod and hooks inside the side and back panel.

4. After the top and bottom panels have been attached, proceed to bolt the front door and frame* on the outside of the left, right and bottom panels.

NOTE: Top and bottom panels have two (2) round, pre-drilled holes that can be found on the back flange and are designed to bolt to the back panel.

* Leave out bottom bolts of front frame if installing foot locker.

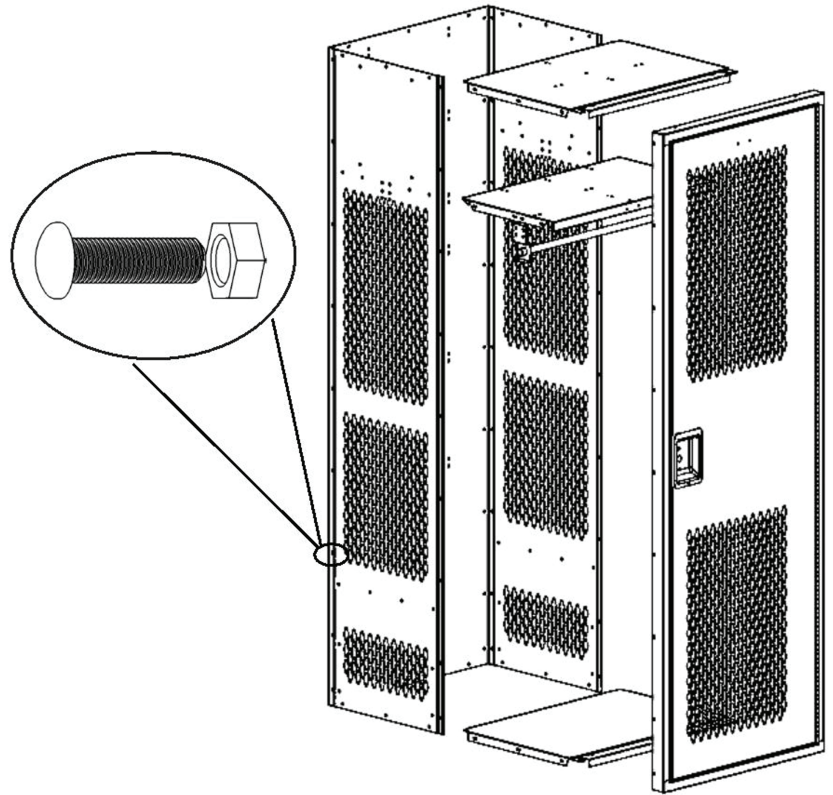

Assembly of Optional Security Box (if applicable)

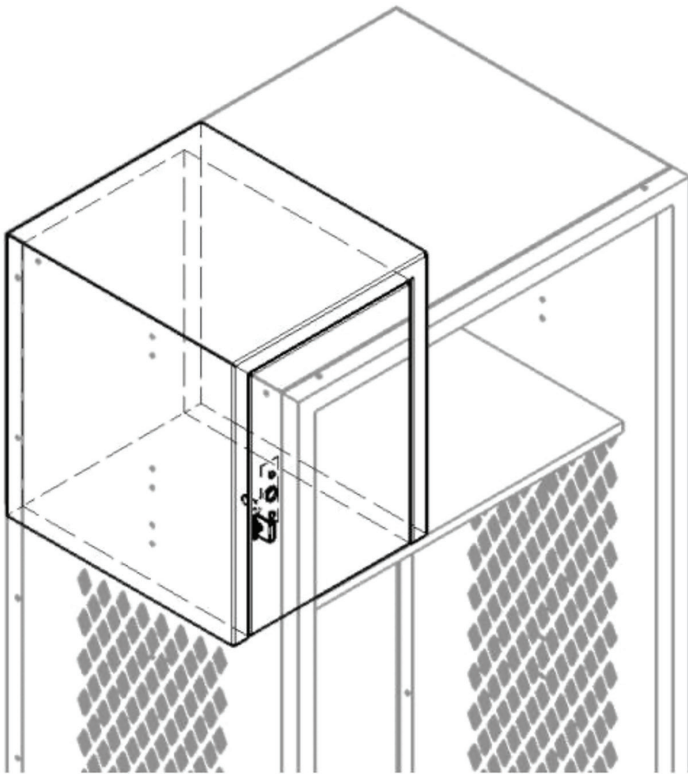

1. Slightly bolt security box side to top panel and shelf.

2. Open door to door frame assembly and bolt the frame to locker top, side, and shelves.

3. Bolt door pull (or lock) to door.

4. Ensure alignment of all parts and tighten loose bolts.

Assembly of Optional Foot Locker

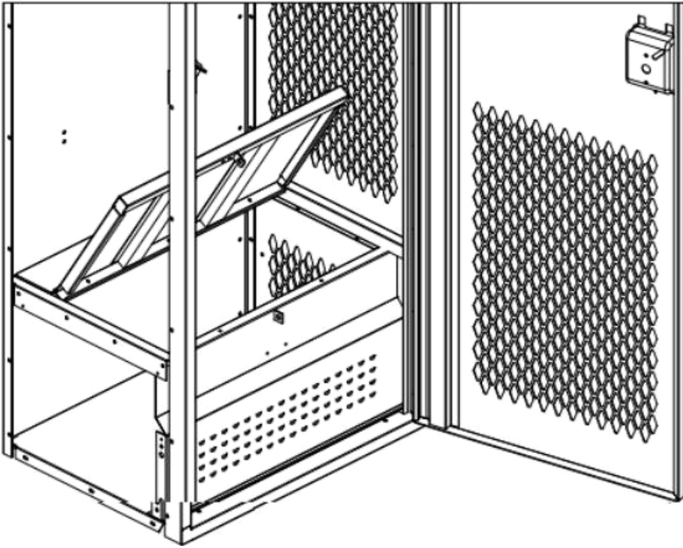

1. Slightly bolt side seat supports to side panels with the seat support slot in the front.
2. Insert back flange of front foot locker panel into slots of side seat supports and loosely bolt in place.
3. Loosely bolt hinged seat to side seat supports.
4. Ensure alignment of all parts and tighten loose bolts.

Insert Front Door Frame

1. Place locker in the upright position and make sure locker is level.
2. Tighten all bolts.
3. To instill proper safety measures, we highly advise anchoring the locker to the floor or wall to avoid injury or theft.

